

Beta WORKER

2025



**PROMOZIONE VALIDA DAL
03/03/2025 AL 29/08/2025**

Prezzi netti I.V.A. esclusa - Salvo esaurimento scorte

INDICE

**CASSETTE
CON BUSSOLE**



3-7

**VALIGIE, CESTELLI
E TROLLEY**



8-17

**CASSETTIERE
CON ASSORTIMENTO**



18-31

**ASSORTIMENTO
C45PRO**



32

**INSERTI
E CRICCHETTI**



33-34

Beta Worker è la linea di utensili pensata per rispondere alle esigenze dei professionisti con soluzioni essenziali e funzionali, caratterizzate da un ottimo rapporto qualità-prezzo.















Scegli l'assortimento più vicino alle tue necessità e scoprirai un perfetto alleato nel tuo lavoro quotidiano.

1/4"

009036042

BW 903E/C42

Assortimento di 13 chiavi a bussola esagonali, 18 inserti per avvitatori, 4 chiavi maschio esagonale piegate e 7 accessori, in cassetta di plastica

| | | | |
|---|------------|---|---------------------------------------|
|  | BW 900 | ○ | 4-4,5-5-5,5-6-7-8-9-10-11-12-13-14 mm |
|  | BW 900E/55 | ⊗ | 126 mm |
|  | BW 900/25 | | |
|  | BW 900/20 | | 50 mm |
|  | BW 900/20L | | 100 mm |
|  | BW 900/42 | | 115 mm |
|  | BW 900/30 | | 150 mm |
|  | BW 96 | ○ | 1,3-1,5-2-2,5 mm |
|  | BW 895/1 | □ | 1/4 - ○ 1/4 |
|  | BW 861LP | ⊕ | ⊕ 0,6x4-0,8x5,5-1,2x6,5 mm |
|  | BW 861PH | ⊕ | ⊕ PH1-PH2-PH3 |
|  | BW 861PZ | ⊕ | ⊕ PZ1-PZ2-PZ3 |
|  | BW 861PE | ○ | ⊕ 3-4-5-6 mm |
|  | BW 861TX | ⊕ | ⊕ T10-T15-T20-T25-T30 |

X
42



€ 43,00

190x160x60 mm

3/8"







009136033

BW 913E/C33

Assortimento di 28 chiavi a bussola esagonali e 5 accessori, in cassetta di plastica

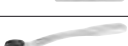
€ 59,00

X
33

| | | | |
|---|------------|---|--|
|  | BW 910A | ○ | 6-7-8-9-10-11-12-13-14-15-16-17-18-19-20-21-22-24 mm |
|  | BW 910AL | ○ | 8-9-10-12-13-14-17-19 mm |
|  | BW 956C | ○ | 16 mm (5/8") 21 mm (13/16") |
|  | BW 910E/55 | ⊗ | 200 mm |
|  | BW 910/25 | | |
|  | BW 910/20 | | 75 mm |
|  | BW 910/22 | | 150 mm |
|  | BW 920/15F | □ | 1/2" - ■ 3/8" |



285x210x84 mm

009236025







1/2"

BW 923E/C25

Assortimento di 20 chiavi a bussola esagonali e 5 accessori, in cassetta di plastica

€ 72,00

X
25

| | | | |
|---|------------|---|--|
|  | BW 920A | ○ | 8-9-10-11-12-13-14-15-16-17-18-19-20-21-22-23-24-27-30-32 mm |
|  | BW 920E/55 | ⊗ | 264 mm |
|  | BW 920/25 | | |
|  | BW 920/21 | | 125 mm |
|  | BW 920/22 | | 250 mm |
|  | BW 910/16F | □ | 3/8" - 1/2" |



285x210x84 mm



1/2" ○

BW 923E-PE/C18

Assortimento di 18 chiavi a bussola per viti con impronta esagonale, in cassetta di plastica

€ 63,00

X
18

| | | | |
|--|-------------|---|--------------------------------|
|  55 mm | BW 920PE | ○ | 4-5-6-7-8-10-12 14-17-19 mm |
|  100 mm | BW 920PE-L | ○ | 4-5-6-7-8 mm |
|  140 mm | BW 920PE-XL | ○ | 10-12-14 mm |



285x210x84 mm

009236018







1/2" 

BW 923E-TX/C18

Assortimento di 18 chiavi a bussola per viti con impronta Torx®, in cassetta di plastica

€ 56,00

X
18

| | | |
|--|-------------|---|
|  55 mm | BW 920TX |  T20-T25-T27-T30-T40-T45-T50-T55-T60-T70 |
|  100 mm | BW 920TX-L |  T20-T25-T27-T30-T40 |
|  140 mm | BW 920TX-XL |  T45-T50-T55 |

 285x210x84 mm



009236017





1/2"  

BW 923E-FTX/C17

Assortimento di 17 chiavi a bussola per viti con profilo Torx®, in cassetta di plastica

€ 40,00

X
17

| | | |
|---|-----------|---|
|  | BW 920FTX |  E10-E12-E14-E16-E18-E20-E22-E24 |
|  | BW 920TX |  T20-T25-T27-T30-T40-T45-T50-T55-T60 |

 285x210x84 mm



009286017

3/4"

BW 928E/C17

Assortimento di 12 chiavi a bussola esagonali e 5 accessori, in cassetta di plastica

€ 199,00

| | | | |
|--|-----------|---|---|
| | BW 928A | ○ | 22-24-27-30-32-34-36 38-41-46-50-55 mm |
| | BW 928/55 | ⊕ | 500 mm |
| | BW 928/25 | | |
| | BW 928/21 | | 100 mm |
| | BW 928/22 | | 200 mm |
| | BW 928/42 | | 455 mm |

555x370x92 mm

X
17



009036098

1/4" 1/2"

BW 903E/C98

Assortimento di 45 chiavi a bussola esagonali, 35 inserti per avvitatori, 4 chiavi maschio esagonali piegate e 14 accessori, in cassetta di plastica

€ 119,00

X
98



375x295x84 mm

1/4"

| | | | |
|--|------------|---|---------------------------------------|
| | BW 900 | ○ | 4-4,5-5-5,5-6-7-8-9-10-11-12-13-14 mm |
| | BW 900L | ○ | 6-7-8-9-10-11-12-13 mm |
| | BW 900E/55 | ⊕ | 126 mm |
| | BW 900/25 | | |
| | BW 900/20 | | 50 mm |
| | BW 900/20L | | 100 mm |
| | BW 900/30 | | 150 mm |
| | BW 900/42 | | 115 mm |

1/2"

| | | | |
|--|------------|---|---|
| | BW 920A | ○ | 10-11-12-13-14-15-16-17-18-19-20-21- 22-24-27-30-32 mm |
| | BW 920AL | ○ | 14-15-17-19-22 mm |
| | BW 956C | ○ | 16 mm (5/8") - 21 mm (13/16") |
| | BW 920E/55 | ⊕ | 264 mm |
| | BW 920/25 | | |
| | BW 920/21 | | 125 mm |
| | BW 920/22 | | 250 mm |

| | | |
|--|------------|------------------------------|
| | BW 910/16F | □ 3/8" - ■ 1/2" |
| | BW 895/6 | □ 1/2" - ◇ 5/16" |
| | BW 895/1 | □ 1/4" - ◇ 1/4" |
| | BW 892/0 | ● 1/4" - ■ 1/4" |
| | BW 861PH | ⊕ ⊕ PH1-PH2 |
| | BW 861PZ | ⊕ ⊕ PZ1-PZ2 |
| | BW 861PE | ○ ⊕ 3-4-5-6 mm |
| | BW 861LP | ● ⊕ 0,6x4-0,8x5,5-1,2x6,5 mm |
| | BW 861TX | ⊕ ⊕ T10-T15-T20-T25-T27-T30 |
| | BW 866LP | ● ⊕ 1,6x8-1,6x10-2,0x12 mm |
| | BW 866PH | ⊕ ⊕ PH3-PH4 |
| | BW 866PZ | ⊕ ⊕ PZ3-PZ4 |
| | BW 866PE | ○ ⊕ 7-8-10-12-14 mm |
| | BW 866TX | ⊕ ⊕ T40-T45-T50-T55-T60-T70 |
| | BW 96 | ○ 1,3-1,5-2-2,5 mm |

009036170

1/4" 3/8" 1/2"

BW 903E/C170

Assortimento di 74 chiavi a bussola esagonali, 42 inserti per avvitatori, 30 chiavi a bussola a giravite, 7 chiavi maschio esagonali piegate e 17 accessori, in cassetta di plastica

**X
170**

€ 199,00

453x375x90 mm



1/4"

| | | | |
|--|-------------------|---|---------------------------------------|
| | BW 900 | ○ | 4-4,5-5-5,5-6-7-8-9-10-11-12-13-14 mm |
| | BW 900L | ○ | 4-5-6-7-8-9-10 mm |
| | BW 900E/55 | ⊗ | 126 mm |
| | BW 900/25 | | |
| | BW 900/20 | | 50 mm |
| | BW 900/20L | | 100 mm |
| | BW 900/30 | | 150 mm |
| | BW 900/42 | | 115 mm |
| | BW 900FTX | ⊗ | E4-E5-E6-E7-E8 |
| | BW 900LP | ● | 0,8x4-1,0x5,5-1,2x6,5-1,2x8 mm |
| | BW 900PH | ⊕ | PH0-PH1-PH2 |
| | BW 900PZ | ⊕ | PZ0-PZ1-PZ2 |
| | BW 900ME | ○ | 3-4-5-6 mm |
| | BW 900TX | ⊗ | T08-T09-T10-T15-T20-T25-T27-T30 |
| | BW 900RTX | ⊗ | T08-T09-T10-T15-T20-T25-T27-T30 |

1/2"

| | | | |
|--|-------------------|-----------------|---|
| | BW 920A | ○ | 10-11-12-13-14-15-16-17-18-19-20-21-22-24-27-30-32 mm |
| | BW 920AL | ○ | 16-17-18-19-22 mm |
| | BW 920FTX | ⊗ | E18-E20-E24 |
| | BW 956C | ○ | 16 mm (5/8") - 21 mm (13/16") |
| | BW 920E/55 | ⊗ | 264 mm |
| | BW 920/25 | | |
| | BW 920/21 | | 125 mm |
| | BW 920/22 | | 250 mm |
| | BW 910/16F | □ 3/8" - ■ 1/2" | |

3/8"

| | | | |
|--|-------------------|---|----------------------------------|
| | BW 910A | ○ | 10-11-12-13-14-15-16-17-18-19 mm |
| | BW 910AL | ○ | 10-11-12-13-14-15 mm |
| | BW 910FTX | ⊗ | E10-E11-E12-E14-E16 |
| | BW 956E | ○ | 18 mm (11/16") |
| | BW 910E/55 | ⊗ | 200 mm |
| | BW 910/25 | | |
| | BW 910/22 | | 150 mm |

| | | | |
|--|-------------------|------------------|--------------------------------|
| | BW 96 | ○ | 0,9-1,5-2-2,5-3-4-5 mm |
| | BW 895/4 | □ 3/8" - ○ 5/16" | |
| | BW 895/6 | □ 1/2" - ○ 5/16" | |
| | BW 895/1 | ○ 1/4" - □ 1/4" | |
| | BW 892/0 | ● 1/4" - ■ 1/4" | |
| | BW 861RTX | ⊗ | T9-T10-T15-T20-T25-T27-T30-T40 |
| | BW 861TX | ⊗ | T6-T7-T8 |
| | BW 861RIBE | ⊗ | 7-8-9 mm |
| | BW 861XZN | ○ | 5-6-8 mm |
| | BW 866LP | ● | 1,6x8-1,6x10-2,0x12 mm |
| | BW 866PH | ⊕ | PH3-PH4 |
| | BW 866PZ | ⊕ | PZ3-PZ4 |
| | BW 866PE | ○ | 7-8-10-12-14 mm |
| | BW 866TX | ⊗ | T40-T45-T50-T55-T60-T70 |
| | BW 866RTX | ⊗ | T40-T45-T50-T55-T60-T70 |

020466116



1/2" 1/4"

BW 2046E/C116

Valigia con assortimento di 116 utensili per manutenzione generale, in plastica

€ 195,00

X
116









453x375x90 mm

















1/4"

| | | | |
|---|-------------------|---|---------------------------------------|
|  | BW 900 | ○ | 4-4,5-5-5,5-6-7-8-9-10-11-12-13-14 mm |
|  | BW 900L | ○ | 6-7-8-9-10-11-12-13 mm |
|  | BW 900E/55 | ⊕ | 126 mm |
|  | BW 900/25 | | |
|  | BW 900/20 | | 50 mm |
|  | BW 900/20L | | 100 mm |
|  | BW 900/30 | | 150 mm |
|  | BW 900/42 | | 115 mm |

1/2"

| | | | |
|---|-------------------|------------------|---|
|  | BW 920A | ○ | 10-11-12-13-14-15-16-17-18-19-20-21-22-24-27-30-32 mm |
|  | BW 920AL | ○ | 14-15-17-19-22 mm |
|  | BW 956C | ○ | 16 mm (5/8") - 21 mm (13/16") |
|  | BW 920E/55 | ⊕ | 264 mm |
|  | BW 920/25 | | |
|  | BW 920/21 | | 125 mm |
|  | BW 920/22 | | 250 mm |
|  | BW 910/16F | □ 3/8" - ■ 1/2" | |
|  | BW 895/6 | □ 1/2" - ○ 5/16" | |

| | | |
|---|------------------|--|
|  | BW 895/1 | □ 1/4" - ○ 1/4" |
|  | BW 892/0 | ● 1/4" - ■ 1/4" |
|  | BW 861PH | ⊕ PH1-PH2 |
|  | BW 861PZ | ⊕ PZ1-PZ2 |
|  | BW 861PE | ○ 3-4-5-6 mm |
|  | BW 861LP | ● 0,6x4-0,8x5,5-1,2x6,5 mm |
|  | BW 861TX | ⊕ T10-T15-T20-T25-T27-T30 |
|  | BW 866LP | ● 1,6x8-1,6x10-2,0x12 mm |
|  | BW 866PH | ⊕ PH3-PH4 |
|  | BW 866PZ | ⊕ PZ3- PZ4 |
|  | BW 866PE | ○ 7-8-10-12-14 mm |
|  | BW 866TX | ⊕ T40-T45-T50-T55-T60-T70 |
|  | BW 42 | ⊕ 7-8-9-10-11-12-13-14-15-16-17-18-19 mm |
|  | BW 96/SC9 | ○ 1,5-2-2,5-3-4-5-6-8-10 mm |

020476008



1/4" 1/2"

BW 2047E/C108

Valigia con assortimento di 108 utensili per manutenzione generale, in plastica

**X
108**

€ 245,00



555x370x92 mm

1/4"

| | | | |
|--|-------------------|---|---------------------------------------|
| | BW 900 | ○ | 4-4,5-5-5,5-6-7-8-9-10-11-12-13-14 mm |
| | BW 900E/55 | ⊗ | 126 mm |
| | BW 900/25 | | |
| | BW 900/20 | | 50 mm |
| | BW 900/20L | | 100 mm |
| | BW 900/30 | | 150 mm |
| | BW 900/42 | | 115 mm |

BW 860EA/31

| | | |
|--|-----------------|--|
| | BW 861LP | 0,5x3-0,6x4,5-0,8x5,5-1,0x5,5-1,2x6,5-1,6x8 mm |
| | BW 861PH | 1-2-3 |
| | BW 861PZ | 1-2-3 |
| | BW 861PE | 2-3-4-5-6-8 mm |
| | BW 861TX | T8-T9-T10-T15-T20 T25-T27-T30-T40 |
| | BW 861PQ | 1-2-3 mm |
| | BW 882M1 | ○ 1/4 - ● 1/4 |



1/2"

| | | | |
|--|-------------------|-----------------|---|
| | BW 920A | ○ | 10-11-12-13-14-15-16-17-18-19-20-21-22-24-27-30-32 mm |
| | BW 956C | ○ | 16 mm (5/8") - 21 mm (13/16") |
| | BW 920E/55 | ⊗ | 264 mm |
| | BW 920/25 | | |
| | BW 920/21 | | 125 mm |
| | BW 920/22 | | 250 mm |
| | BW 910/16F | □ 3/8" - ■ 1/2" | |

| | | |
|--|------------------|--|
| | BW 895/1 | □ 1/4" - ○ 1/4" |
| | BW 42 | ⊗ 7-8-9-10-11-12-13-14-15-16-17-18-19 mm |
| | BW 96/SC9 | ○ 1,5-2-2,5-3-4-5-6-8-10 mm |
| | BW 1048 | 250 mm |
| | BW 1082BM | 160 mm |
| | BW 1150BM | 180 mm |
| | BW 1166BM | 160 mm |
| | 1201E | ● 3x75-4x100-5,5x125 6,5x150mm |
| | 1202E | ⊕ PH1-PH2 |
| | BW 1370 | ⊗ 300 g |

020546001



14"

X
100

BW 2054E-100

Valigia con assortimento di 100 utensili per manutenzione generale

- Vassoio morbido in EVA incluso

€ 239,00

400x300x140 mm



| | | |
|--|--------------|---------------------------------------|
| | BW 42 | 6-7-8-9-10-11-12-13-14-15-16-17-19 mm |
| | BW 96BPC/SC9 | 1,5-2-2,5-3-4-5-6-8-10 mm |
| | BW 1048 | 250 mm |
| | BW 1082BM | 160 mm |
| | BW 1150BM | 180 mm |
| | BW 1166BM | 160 mm |
| | 1201E | 3x75-5,5x100-6,5x150 mm |
| | 1202E | PH0x60-PH1x80-PH2x100 mm |
| | BW 1253 | 3,5x100 mm |
| | BW 1370 | 300 g |
| | BW 1692/3 | 3 m |
| | 1770A | 9 mm |
| | BW 1770RL | 10x |
| | BW 1778SCL | 170 mm |
| | BW 1725CR | 150 mm |

BW 860EA/31

| | | |
|--|----------|--|
| | BW 861LP | 0,5x3-0,6x4,5-0,8x5,5-1,0x5,5-1,2x6,5-1,6x8 mm |
| | BW 861PH | 1-2-3 |
| | BW 861PZ | 1-2-3 |
| | BW 861PE | 2-3-4-5-6-8 mm |
| | BW 861TX | T8-T9-T10-T15-T20-T25-T27-T30-T40 |
| | BW 861PQ | 1-2-3 mm |
| | BW 882M1 | ○ 1/4 - ● 1/4 |



14"

| | | |
|--|------------|---|
| | BW 882P/80 | ○ 1/4 - ● 1/4 |
| | BW 895/1 | ○ 1/4 - □ 1/4 |
| | BW 900 | ○ 4-4,5-5-5,5-6-7-8-9-10-11-12-13-14 mm |
| | BW 900/20 | 50 mm |
| | BW 900/20L | 100 mm |
| | BW 900/25 | |
| | BW 900/30 | 150 mm |
| | BW 900/42 | 115 mm |
| | BW 900/55 | 150 mm |

020546002



14" 3/8"

BW 2054E-128

Valigia con assortimento di 128 utensili per manutenzione generale

- Vassoio morbido in EVA incluso

€ 289,00



BW 860EA/31

| | | |
|---|----------|--|
| ● | BW 861LP | 0,5x3-0,6x4,5-0,8x5,5-1,0x5,5-1,2x6,5-1,6x8 mm |
| ⊕ | BW 861PH | 1-2-3 |
| ⊕ | BW 861PZ | 1-2-3 |
| ○ | BW 861PE | 2-3-4-5-6-8 mm |
| ⊕ | BW 861TX | T8-T9-T10-T15-T20 T25-T27-T30-T40 |
| ○ | BW 861PQ | 1-2-3 mm |
| ○ | BW 882M1 | ○ 1/4 - ● 1/4 |



BW 1256/C21-1

| | | |
|------|------------|----------------------------|
| ● | BW 1256LP | 1,5-2-2,5 mm |
| ⊕ | BW 1256PH | PH0-PH1 |
| ⊕ | BW 1256PZ | PZ0-PZ1 |
| ○ | BW 1256PE | 0,7-0,9-1,3-1,5-2-2,5-3 mm |
| ⊕ | BW 1256TX | T4-T5-T6-T7 |
| ⊕ | BW 1256RTX | T8-T10-T15 |
| 4 mm | | 99 mm |



400x300x140 mm

X
128

| | | |
|--|--------------|-------------------------------------|
| | BW 42 | 7-8-9-10-11-12-13-14-15-16-17-19 mm |
| | BW 96BPC/SC9 | 1,5-2-2,5-3-4-5-6-8-10 mm |
| | BW 1048 | 250 mm |
| | BW 1082BM | 160 mm |
| | BW 1150BM | 180 mm |
| | BW 1166BM | 160 mm |
| | 1201E | 3x75-5,5x100-6,5x150 mm |
| | 1202E | PH0x60-PH1x80-PH2x100 mm |
| | BW 1128BMX | 150 mm |
| | BW 1370 | 300 g |
| | BW 1692/3 | 3 m |
| | 1771 | 18 mm |
| | BW 1771RL | 10x |
| | BW 1833S | 105 mm (pila 1xAA - non inclusa) |

1/4"

| | | |
|--|------------|--------------------------------------|
| | BW 895/1 | ○ 1/4 - □ 1/4 |
| | BW 900 | ○ 4-4,5-5-5,5-6-7-8-9-10-11-12-13 mm |
| | BW 900/20L | 100 mm |
| | BW 900/25 | |
| | BW 900/30 | 150 mm |
| | BW 900/42 | 115 mm |
| | BW 900/55 | 150 mm |

3/8"

| | | |
|--|------------|---------------------------|
| | BW 910A | ○ 14-15-17-18-19-22-24 mm |
| | BW 910/22 | 150 mm |
| | BW 910/25 | |
| | BW 910/55 | 200 mm |
| | BW 920/15F | □ 1/2" - ■ 3/8" |

020566010

14" 12"

BW 2056E

Valigia con assortimento di 163 utensili per manutenzione generale

- Pannello interno removibile
- Vassoio morbido in EVA incluso

€ 365,00

465x330x170 mm



020566110

14" 12"

BW 2056T/E

Valigia trolley con assortimento di 163 utensili per manutenzione generale

- Manico telescopico regolabile
- Pannello interno removibile
- Vassoio morbido in EVA incluso

€ 399,00

465x330x225 mm



ASSORTIMENTO 163 UTENSILI

| | | | | | |
|--|--------------|--|--|------------|-------------------|
| | BW 42 | 8-9-10-11-12-13-14-15-16-17-18-19 mm | | 1202E | PH1x80-PH2x100 mm |
| | BW 96BPC/SC9 | 1,5-2-2,5-3-4-5-6-8-10 mm | | 1209E/PZ | PZ1x80-PZ2x100 mm |
| | BW 111 | 250 mm | | BW 1128BMX | 150 mm |
| | BW 1048 | 250 mm | | BW 1253 | 3,5x100 mm |
| | BW 1082BM | 160 mm | | BW 1370 | 300 g |
| | BW 1150BM | 180 mm | | BW 1692/5 | 5 m |
| | BW 1166BM | 160 mm | | BW 1725CR | 150 mm |
| | 1201E | 2,5x50-3x75-4x125-5,5x150-6,5x150-8x150 mm | | 1771 | 18 mm |

14"

| | | |
|--|------------|---------------------------------------|
| | BW 895/1 | 1/4 - 1/4 |
| | BW 900 | 4-4,5-5-5,5-6-7-8-9-10-11-12-13-14 mm |
| | BW 900/20 | 50 mm |
| | BW 900/20L | 100 mm |
| | BW 900/25 | |
| | BW 900/30 | 150 mm |
| | BW 900/42 | 115 mm |
| | BW 900/55 | 150 mm |

12"

| | | |
|--|------------|---|
| | BW 920A | 10-11-12-13-14-15-16-17-18-19-21-22-24 mm |
| | BW 920/21 | 125 mm |
| | BW 920/22 | 250 mm |
| | BW 910/16F | 3/8" - 1/2" |
| | BW 920/25 | |
| | BW 920/55 | 260 mm |

BW 861/C61

| | | |
|--|----------|--|
| | BW 861LP | 0,5x3 (2)-0,5x4(2)-0,6x4,5(2)-0,8x5(2)-1,0x5,5(2)-1,0x6(2)-1,6x8(2) mm |
| | BW 861PH | PH0(2)-PH1(7)-PH2(7)-PH3(2) |
| | BW 861PZ | PZ0(2)-PZ1(3)-PZ2(3)-PZ3(2) |
| | BW 861PE | 1,5-2-2,5-3-4-4,5-5-5,5-6-8 mm |
| | BW 861TX | T9-T10-T15-T20-T25 T27-T30-T40 |
| | BW 882M1 | 1/4 - 1/4 |



BW 1256/C21-1

| | | |
|--|------------|----------------------------|
| | BW 1256LP | 1,5-2-2,5 mm |
| | BW 1256PH | PH0-PH1 |
| | BW 1256PZ | PZ0-PZ1 |
| | BW 1256PE | 0,7-0,9-1,3-1,5-2-2,5-3 mm |
| | BW 1256TX | T4-T5-T6-T7 |
| | BW 1256RTX | T8-T10-T15 |
| | 4 mm | 99 mm |



020566022



X
147

BW 2056E 12V/19P

Valigia con assortimento di 147 UTENSILI per manutenzione generale incluso il nuovo TRAPANO AVVITATORE 12V

- Pannello interno removibile
- Vassoio morbido in EVA incluso

NUOVO PREZZO RIBASSATO

€ 399,00



Guarda il video



| | | | |
|--|--------------|--|--|
| | BW 42 | | 8-9-10-11-12-13-14-15-16-17-18-19 mm |
| | BW 96BPC/SC9 | | 1,5-2-2,5-3-4-5-6-8-10 mm |
| | BW 111 | | 250 mm |
| | BW 1048 | | 250 mm |
| | BW 1082BM | | 160 mm |
| | BW 1150BM | | 180 mm |
| | BW 1166BM | | 160 mm |
| | 1201E | | 2,5x50-3x75-4x125-5,5x150-6,5x150-8x150 mm |
| | 1202E | | PH1x80-PH2x100 mm |
| | 1209E/PZ | | PZ1x80-PZ2x100 mm |
| | BW 1128BMX | | 150 mm |
| | BW 1253 | | 3,5x100 mm |
| | BW 1370 | | 300 g |
| | BW 1692/5 | | 5 m |
| | BW 1725CR | | 150 mm |
| | 1771 | | 18 mm |
| | BW 1696 | | 300 mm |

| | | |
|--|----------------|---------------|
| | 1972/12V-10 | |
| | 1994BL 12V-2AH | |
| | 1994CB 12V | |
| | 410/SEL19 | Ø 1÷10x0,5 mm |

1/4"

| | | | |
|--|------------|--|---|
| | BW 895/1 | | ○ 1/4 - □ 1/4 |
| | BW 900 | | ○ 4-4,5-5-5,5-6-7-8-9-10-11-12-13-14 mm |
| | BW 900/20 | | 50 mm |
| | BW 900/20L | | 100 mm |
| | BW 900/25 | | |
| | BW 900/30 | | 150 mm |
| | BW 900/42 | | 115 mm |
| | BW 900/55 | | 150 mm |

BW 861/C61

| | | |
|--|----------|--|
| | BW 861LP | 0,5x3 (2)-0,5x4(2)-0,6x4,5(2)-0,8x5(2)-1,0x5,5(2)-1,0x6(2)-1,6x8(2) mm |
| | BW 861PH | PH0(2)-PH1(7)-PH2(7)-PH3(2) |
| | BW 861PZ | PZ0(2)-PZ1(3)-PZ2(3)-PZ3(2) |
| | BW 861PE | 1,5-2-2,5-3-4-4,5-5-5,5-6-8 mm |
| | BW 861TX | T9-T10-T15-T20-T25 T27-T30-T40 |
| | BW 862M1 | ○ 1/4 - ● 1/4 |



021206911

12"

BW 2120L-E/T91

Cestello in lamiera con assortimento di 91 utensili per manutenzione generale, in termoformato rigido in ABS

X
91

€ 295,00



550x200x210 mm

12"



| | | | |
|-----------|---|--|----|
| BW 920A | ○ | 10-11-12-13-14-15-16-17-18-19-20-21-22-23-24-27-30-32 mm | 20 |
| BW 920/55 | ⊗ | 250 mm | |
| BW 920/25 | | | |



| | | | |
|------------|-----------------|--------|---|
| BW 920/21 | ○ | 125 mm | 5 |
| BW 920/22 | | 250 mm | |
| BW 910/16F | □ 3/8" - ■ 1/2" | | |
| BW 1048 | | 250 mm | |
| 1771 | | 18 mm | |



| | | | |
|-----------|---|-----------------------------------|----|
| BW 42 | ⊗ | 8-9-10-11-12-13-14-15-16-17-19 mm | 20 |
| BW 96/SC9 | ○ | 1,5-2-2,5-3-4-5-6-8-10 mm | |



| | | | |
|--------|---|--------------------------------------|---|
| 1201E | ● | 2,5x50-3x75-4x100-5,5x125-6,5x150 mm | 6 |
| 1201EN | ● | 4x30 mm | |



| | | | |
|-------------|---------------|--------------------------|----|
| BW 860EA/31 | ⊗ ⊙ ⊕ ⊖ ⊗ ⊘ | | 37 |
| BW 895/1 | ○ 1/4 - □ 1/4 | | |
| BW 900/30 | | 150 mm | |
| 1202E | ⊕ | PH0x60-PH1x80-PH2x100 mm | |
| 1202EN | ⊕ | PH1x30 mm | |



| | | | |
|-----------|---|--------|---|
| BW 1082BM | ⌢ | 160 mm | 3 |
| BW 1150BM | ≡ | 180 mm | |
| BW 1166BM | ● | 160 mm | |

022006130

BW C22E

Cassettera portatile 3 cassetti

- 3 cassetti da 435x210x50 mm, montati su guide telescopiche a sfera
- Vano superiore da 505x256x60 mm
- Serratura centralizzata frontale
- Maniglia sul coperchio
- Maniglie laterali a scomparsa per il trasporto

| n° | h | max |
|----|-------|------|
| 3 | 50 mm | 5 kg |

€ 117,00

510x268x350 mm

20 kg



022006201

BW 2200E/21

Cassettera portatile con assortimento di 159 utensili, in vassoio morbido in EVA



€ 373,00

510x268x350 mm

1/2" 1/4"



| | | | |
|--------------|--------------------------------|---------|------------------|
| BW 96BPC/SC9 | ○ 1,5-2-2,5-3-4-5-6-8-10 mm | 1202E | ● PH1X80-8-10 mm |
| 1201E | ● 2,5x50-3x75-4x100-5,5x125 mm | 1202EN | ● PH1X30 mm |
| 1201EN | ● 4X30 | BW 1253 | ● 3,5x100 mm |



| | | | |
|-----------|------------------------------|-----------|----------|
| BW 42 | 8-10-11-12-13-14-15-17-19 mm | BW 1150BM | = 180 mm |
| BW 1082BM | ↑ 160 mm | 1770A | 9 mm |
| | | BW 1770RL | 10x |

1/4"

1/2"



| | | | |
|---------------|-------------|------------|---------------------------------------|
| BW 861/C61 | ① ② ③ ④ ⑤ ⑥ | BW 900 | ① ② ③ ④ ⑤ ⑥ ⑦ ⑧ ⑨ ⑩ ⑪ ⑫ ⑬ ⑭ ⑮ ⑯ ⑰ ⑱ ⑲ |
| BW 1256/C21-1 | ○ 4 mm | BW 900/20 | ① 50 mm |
| BW 900/55 | ① 150 mm | BW 900/20L | ① 100 mm |
| BW 920/55 | ① 260 mm | BW 920/25 | ① |
| BW 900/25 | ① | BW 920/22 | ① 250 mm |
| BW 900/42 | ① 115 mm | BW 910/16F | ① 3/8" - ② 1/2" |
| BW 895/1 | ① ② | BW 920A | ① ② ③ ④ ⑤ ⑥ ⑦ ⑧ ⑨ ⑩ ⑪ ⑫ ⑬ ⑭ ⑮ ⑯ ⑰ ⑱ ⑲ |

X
159

| | | |
|--|------------|--------|
| | BW 1048 | 250 mm |
| | BW 1128BMX | 150 mm |
| | BW 1370 | 300 g |
| | BW 1692 | 5 m |

043006003

BW C43

€ 159,00

Trolley portautensili a tre moduli sovrapponibili

- Struttura in lamiera e materiale plastico
- 3 moduli separabili:
 - 1 cestello superiore, altezza 222 mm
 - 1 modulo centrale, altezza 168 mm con 2 cassette altezza 60 mm
 - 1 modulo inferiore, altezza 332 mm con sportello basculante altezza 280 mm con ruote
- Ruote ø 128 mm
- Manico telescopico regolabile in 4 posizioni
- Sistema di sgancio dei moduli con accesso a tutti i diversi scomparti portautensili
- Cestello superiore con vassoio portaoggetti interno rimovibile e 2 portaminuterie integrati nel coperchio

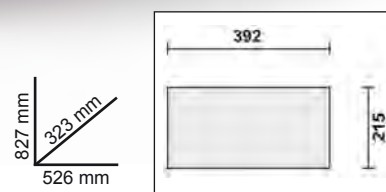

3 moduli sovrapponibili



043006201

BW 4300E/21

Trolley portautensili BW C43
con assortimento di 212 utensili universali

€ 499,00



X
212

| | | | |
|--|----------------|--|---|
| | BW 42 | | 7-8-9-10-11-12-13-14-15-16-17-18-19-22 mm |
| | BW 96BPC/SC9 | | 1,5-2-2,5-3-4-5-6-8-10 mm |
| | BW 111 | | 200 mm |
| | BW 1048 | | 250 mm |
| | BW 1052 | | 240 mm |
| | BW 1082BM | | 160 mm |
| | BW 1150BM | | 180 mm |
| | BW 1166BM | | 160 mm |
| | 1201E | | 2,5x50-3x75-4x100-5,5x150-6,5x150 mm |
| | 1201EN | | 4x30 mm |
| | 1202E | | PH0x60-PH1x80-PH2x100 mm |
| | 1202EN | | PH1x30 mm |
| | BW 1128BMX | | 150 mm |
| | BW 1253 | | 3,5x100 mm |
| | BW 1370 | | 300 g |
| | BW 1390 | | Ø 35 mm |
| | BW 1692 | | 3 m |
| | BW 1696 | | 300 mm |
| | 1771 | | 18 mm |
| | BW 1771RL | | 10x |
| | BW 1725CR | | 150 mm |
| | BW 1098 | | 220 mm |
| | BW 1719BMA...P | | 200 mm |
| | BW 1719BMA...M | | 200 mm |
| | BW 1719BMA...R | | 200 mm |
| | BW 1833S | | 105 mm (pile 1xAA - non incluse) |

BW 861/C61

| | | |
|--|----------|--|
| | BW 861LP | 0,5x3 (2)-0,5x4(2)-0,6x4,5(2)-0,8x5(2)-1,0x5,5(2)-1,0x6(2)-1,6x8(2) mm |
| | BW 861PH | PH0(2)-PH1(7)-PH2(7)-PH3(2) |
| | BW 861PZ | PZ0(2)-PZ1(3)-PZ2(3)-PZ3(2) |
| | BW 861PE | 1,5-2-2,5-3-4-4,5-5-5,5-6-8 mm |
| | BW 861TX | T9-T10-T15-T20-T25 T27-T30-T40 |
| | BW 882M1 | ○ 1/4 - ● 1/4 |



BW 1256/C21-1

| | | |
|------|------------|----------------------------|
| | BW 1256LP | 1,5-2-2,5 mm |
| | BW 1256PH | PH0-PH1 |
| | BW 1256PZ | PZ0-PZ1 |
| | BW 1256PE | 0,7-0,9-1,3-1,5-2-2,5-3 mm |
| | BW 1256TX | T4-T5-T6-T7 |
| | BW 1256RTX | T8-T10-T15 |
| 4 mm | | 99 mm |



BW 903E/C42 1/4"

| | | | |
|--|------------|--|---------------------------------------|
| | BW 900 | | 4-4,5-5-5,5-6-7-8-9-10-11-12-13-14 mm |
| | BW 900E/55 | | 126 mm |
| | BW 900/25 | | |
| | BW 900/20 | | 50 mm |
| | BW 900/20L | | 100 mm |
| | BW 900/42 | | 115 mm |
| | BW 900/30 | | 150 mm |
| | BW 96 | | 1,3-1,5-2-2,5 mm |
| | BW 895/1 | | 1/4 - □ 1/4 |
| | BW 861LP | | 0,6x4-0,8x5,5-1,2x6,5 mm |
| | BW 861PH | | PH1-PH2-PH3 |
| | BW 861PZ | | PZ1-PZ2-PZ3 |
| | BW 861PE | | 3-4-5-6 mm |
| | BW 861TX | | T10-T15-T20-T25-T30 |

BW 923E/C25 1/2"

| | | | |
|--|------------|--|--|
| | BW 920A | | 8-9-10-11-12-13-14-15-16-17-18-19-20-21-22-23-24-27-30-32 mm |
| | BW 920E/55 | | 264 mm |
| | BW 920/25 | | |
| | BW 920/21 | | 125 mm |
| | BW 920/22 | | 250 mm |
| | BW 910/16F | | □ 3/8" - ■ 1/2" |





BW 5000S/3M

Carrello di servizio con tre cassetti e assortimento di 189 utensili

- Piano di lavoro termoplastico
- 3 cassetti da 588x367 mm altezza 70 mm, montati su guide telescopiche a sfera
- Piano dei cassetti protetto da tappetini di gomma espansa
- Serratura di sicurezza centralizzata frontale
- Pratico portagiravite laterale incluso
- Due portabombolette laterali integrati nella struttura
- Ampio ripiano inferiore protetto con tappetino in gomma antiolio e antibenzina
- Quattro ruote Ø 125 mm:
2 fisse e 2 girevoli (una con freno)
- Capacità di carico statico: 400 kg
- Portata di ogni cassetto:
15 kg uniformemente distribuiti

**X
189**

400 kg

€ 749,00

**SPAZIOSO VANO
PER RIPORRE OGGETTI
PIÙ VOLUMINOSI**



| n° | h | ↓ max |
|----|-------|-------|
| 3 | 70 mm | 15 kg |



050006331



050006332



050006333

Sistema di apertura in nylon rinforzato



Ruote con nucleo in metallo per una maggior resistenza

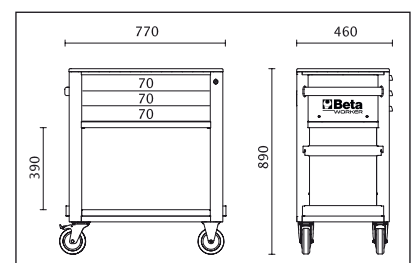
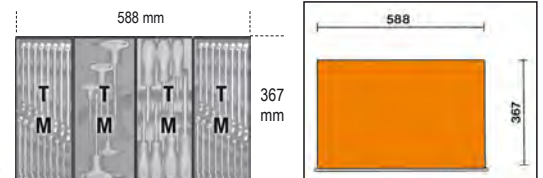



31

- BW 42 6-7-8-9-10-11-12-13-14-15-16-17-18-19-20-21-22-23-24 mm
- 1201E 2,5x50-3x75-4x100-5,5x125-6,5x150-8x200 mm
- 1202E PH0x60-PH1x80-PH2x100-PH3x150 mm
- 1201EN 4x30 mm
- 1202EN PH1x30 mm

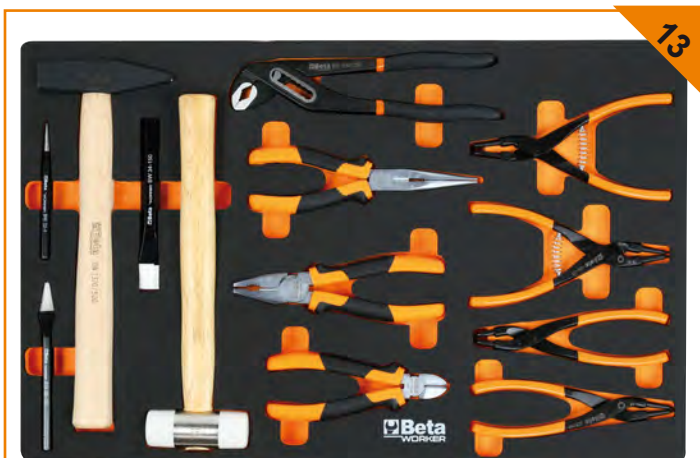

13

- BW 32 Ø 4 mm
- BW 34 150 mm
- BW 36 150 mm
- BW 1048 250 mm
- BW 1082BM 160 mm
- BW 1150BM 180 mm
- BW 1166BM 200 mm
- BW 1370 500 g
- BW 1390 Ø 35 mm
- 1032 Ø 180 mm
- 1034 Ø 170 mm
- 1036 Ø 175 mm
- 1038 Ø 175 mm



145

- 14** BW 900 4-4,5-5-5,5-6-7-8-9-10-11-12-13-14 mm
- BW 900ME 3-4-5-6-7-8 mm
- BW 900TX T06-T07-T08-T09-T10-T15-T20-T25
- BW 900/20 50 mm
- BW 900/20L 100 mm
- BW 900/25
- BW 900/30 150 mm
- BW 900/42 115 mm
- BW 900/55 150 mm
- BW 895/1 1/4" - 1/4"

- BW 96BPC/SC9 1,5-2-2,5-3-4-5-6-8-10 mm
- BW 111 250 mm

- 12** BW 920A 8-9-10-11-12-13-14-15-16-17-18-19-20-21-22-23-24-27-30-32 mm
- BW 920PE 5-6-7-8-9-10-12-14 mm
- BW 920TX T27-T30-T40-T45-T50-T55-T60
- BW 920/21 125 mm
- BW 920/22 250 mm
- BW 910/16F 3/8" - 1/2"
- BW 920/25
- BW 920/55 260 mm

BW 861/C61

| | | |
|---|----------|--|
| ⊖ | BW 861LP | 0,5x3 (2)-0,5x4(2)-0,6x4,5(2)-0,8x5(2)-1,0x5,5(2)-1,0x6(2)-1,6x8(2) mm |
| + | BW 861PH | PH0(2)-PH1(7)-PH2(7)-PH3(2) |
| + | BW 861PZ | PZ0(2)-PZ1(3)-PZ2(3)-PZ3(2) |
| ○ | BW 861PE | 1,5-2-2,5-3-4-4,5-5-5,5-6-8 mm |
| ⊗ | BW 861TX | T9-T10-T15-T20-T25 T27-T30-T40 |
| ⊖ | BW 882M1 | 1/4 - 1/4 |



024006201



BW C04BOX-A VU

Cassettiera con sei cassetti
e assortimento
di 196 utensili universali
in vassoio morbido in EVA

- Piano di lavoro in ABS con 6 vaschette portaminuterie
- 6 cassetti da 570x410 mm, montati su guide telescopiche a sfera
- Piano dei cassetti protetto da tappetini di gomma espansa
- Quattro ruote Ø 125 mm: 2 fisse e 2 girevoli con freno
- Serratura di sicurezza centralizzata frontale
- Capacità di carico statico: 150 kg

X
196

150 kg

€ 699,00

**PREZZO
IMBATTIBILE!**



Piano di lavoro in ABS con
6 vaschette portaminuterie



Ruote con nucleo in metallo
per una maggior resistenza



| n° | h | max |
|----|--------|-------|
| 1 | 80 mm | 20 kg |
| 4 | 110 mm | 20 kg |
| 1 | 160 mm | 25 kg |

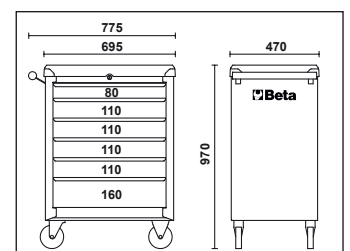
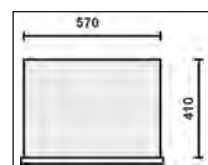



36

BW 42 6-7-8-9-10-11-12-13-14-15-16-17-19-21-22-24 mm
BW 96BPC/SC9 1,5-2-2,5-3-4-5-6-8-10 mm
BW 1719BMA8/P 200 mm
BW 1719BMA8/M 200 mm
BW 1719BMA8/R 200 mm

BW 1128BMX 1201E 150 mm
 3,5x100-5,5x150-6,5x150 mm
 4x30 mm
 PH1x80-PH2x100 mm
 PH1x30

23

BW 31 2-3-4-5-6 mm
BW 1771 18 mm
BW 1048 250 mm
BW 1082BM 160 mm
BW 1150BM 180 mm

BW 1166BM 160 mm
BW 1692/3 3 m
BW 1370 300 g
BW 1390 35 mm
BW 1771RL 18 mm

137

- 14"** **BW 900** 4-4,5-5-5,5-6-7-8-9-10-11-12-13-14 mm
BW 900L 6-7-8-9-10-11-12-13 mm
BW 895/1 1/4 - 1/4
BW 900/20 50 mm
BW 900/20L 100 mm
BW 900/25
BW 900/30 150 mm
BW 900/42 115 mm
BW 900/55 150 mm

BW 861/C61

| | | |
|---|----------|--|
| ● | BW 861LP | 0,5x3 (2)-0,5x4(2)-0,6x4,5(2)-0,8x5(2)-1,0x5,5(2)-1,0x6(2)-1,6x8(2) mm |
| + | BW 861PH | PH0(2)-PH1(7)-PH2(7)-PH3(2) |
| + | BW 861PZ | PZ0(2)-PZ1(3)-PZ2(3)-PZ3(2) |
| ○ | BW 861PE | 1,5-2-2,5-3-4-4,5-5-5,5-6-8 mm |
| ⊗ | BW 861TX | T9-T10-T15-T20-T25 T27-T30-T40 |
| □ | BW 882M1 | 1/4 - 1/4 |

- 12"** **BW 920A** 12-13-14-15-16-17-18-19-20-21-22-24-27-30-32 mm
BW 920AL 14-15- 17-19 mm
BW 920/21 125 mm
BW 920/22 250 mm
BW 910/16F 3/8" - 1/2"
BW 920/25
BW 920/55 260 mm
BW 956C 16- 20,8 mm

BW 1256/C21-1

| | | |
|------|------------|----------------------------|
| ● | BW 1256LP | 1,5-2-2,5 mm |
| + | BW 1256PH | PH0-PH1 |
| + | BW 1256PZ | PZ0-PZ1 |
| ○ | BW 1256PE | 0,7-0,9-1,3-1,5-2-2,5-3 mm |
| ⊗ | BW 1256TX | T4-T5-T6-T7 |
| ⊗ | BW 1256RTX | T8-T10-T15 |
| 4 mm | | 99 mm |

BW 2400S 7/I-S

Cassettiera mobile con sette cassetti e assortimento di 235 utensili

- 7 cassetti da 588x367 mm, montati su guide telescopiche a sfera:
- 5 cassetti altezza 70 mm
- 1 cassetto altezza 140 mm
- 1 cassetto altezza 210 mm
- Piano dei cassetti protetto da tappetini di gomma espansa
- Quattro ruote Ø 125 mm:
- 2 fisse e 2 girevoli (una con freno)
- Serratura di sicurezza centralizzata frontale
- Capacità di carico statico: 800 kg
- Piano di lavoro termoplastico
- Portaflaconi laterale integrato

X
235

800 kg



€ 999,00



024006220



024006232



024006233

| n° | h | max |
|----|--------|-------|
| 5 | 70 mm | 25 kg |
| 1 | 140 mm | 30 kg |
| 1 | 210 mm | 30 kg |

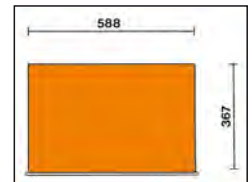
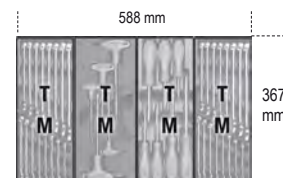

Sistema di apertura in nylon rinforzato



Ruote con nucleo in metallo per una maggior resistenza

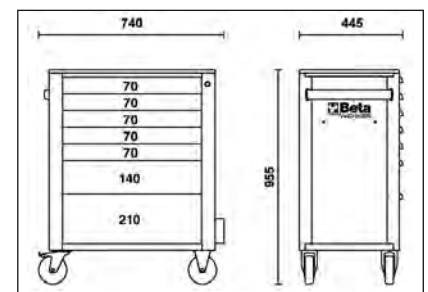



32

1201E Ⓞ 2,5x50-3x75-4x100-5,5x125-6,5x150-8x200 mm
 1201EN Ⓞ 4x30 mm
 1202E Ⓞ PH0x60-PH1x80-PH2x100-PH3x150 mm
 1202EN Ⓞ PH1x30 mm
 1207E/TX Ⓞ T6-T7-T8-T9-T10-T15-T20-T25-T27-T30-T40
 BW 96BPC/SC9 Ⓞ 1,5-2-2,5-3-4-5-6-8-10 mm

31

BW 42 Ⓞ 6-7-8-9-10-11-12-13-14-15-16-17-18-19-20-21-22-23-24-27-30-32 mm
 BW 96BPC/SC9 Ⓞ 1,5-2-2,5-3-4-5-6-8-10 mm

73

BW 32 Ⓞ 4 mm
 BW 34 150 mm
 BW 36 150 mm
 1032 Ⓞ 19+60 mm
 1034 Ⓞ 19+60 mm
 1036 ● 19+60 mm
 1038 ● 19+60 mm
 BW 1048 250 mm
 BW 1082BM ⚡ 160 mm
 BW 1150BM ⚡ 180 mm
 BW 1166BM ● 200 mm
 BW 1370 ⚡ 500 g
 BW 1390 Ⓞ 35 mm

159

1/4" BW 900 Ⓞ 4-4-5-5-5-5-6-7-8-9-10-11-12-13-14 mm
 BW 900L Ⓞ 4-4-5-5-5-5-6-7-8-9-10-11-12-13-14 mm
 BW 900ME Ⓞ 3-4-5-6-7-8 mm
 BW 900TX Ⓞ T6-T7-T8-T9-T10-T15-T20-T25
 BW 895/1 Ⓞ 1/4 - □ 1/4
 BW 900/20 50 mm
 BW 900/20L 100 mm
 BW 900/25 150 mm
 BW 900/30 150 mm
 BW 900/42 115 mm
 BW 900/55 Ⓞ 150 mm

12" BW 920A Ⓞ 8-9-10-11-12-13-14-15-16-17-18-19-20-21-22-23-24-27-30-32 mm
 BW 920AL Ⓞ 10-12-13-14-15-16-17-18-19-21-22 mm
 BW 920PE Ⓞ 5-6-7-8-9-10-12-14 mm
 BW 920TX Ⓞ T27-T30-T40-T45-T50-T55-T60
 BW 920/21 125 mm
 BW 920/22 250 mm
 BW 910/16F □ 3/8" - ■ 1/2"
 BW 920/25 125 mm
 BW 920/55 Ⓞ 260 mm

BW 861/C61 Ⓞ

| | | |
|---|----------|--|
| Ⓞ | BW 861LP | 0,5x3 (2)-0,5x4(2)-0,6x4,5(2)-0,8x5(2)-1,0x5,5(2)-1,0x6(2)-1,6x8(2) mm |
| + | BW 861PH | PH0(2)-PH1(7)-PH2(7)-PH3(2) |
| + | BW 861PZ | PZ0(2)-PZ1(3)-PZ2(3)-PZ3(2) |
| Ⓞ | BW 861PE | 1,5-2-2,5-3-4-4,5-5-5,5-6-8 mm |
| Ⓞ | BW 861TX | T9-T10-T15-T20-T25 T27-T30-T40 |
| Ⓞ | BW 882M1 | Ⓞ 1/4 - ● 1/4 |



BW 2400S 7/E-M

Cassettiera mobile con sette cassetti e assortimento di 309 utensili

- 7 cassetti da 588x367 mm, montati su guide telescopiche a sfera:
- 5 cassetti altezza 70 mm
- 1 cassetto altezza 140 mm
- 1 cassetto altezza 210 mm
- Piano dei cassetti protetto da tappetini di gomma espansa
- Quattro ruote Ø 125 mm:
- 2 fisse e 2 girevoli (una con freno)
- Serratura di sicurezza centralizzata frontale
- Capacità di carico statico: 800 kg
- Piano di lavoro termoplastico
- Portaflaconi laterale integrato

800 kg

X
309



€ 1.249,00

| n° | h | max |
|----|--------|-------|
| 5 | 70 mm | 25 kg |
| 1 | 140 mm | 30 kg |
| 1 | 210 mm | 30 kg |



024006224



024006225



024006226

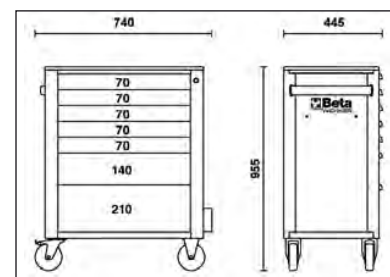
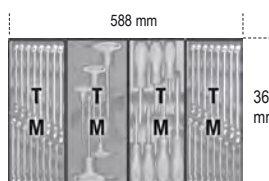
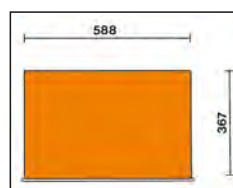

Sistema di apertura in nylon rinforzato



Ruote con nucleo in metallo per una maggior resistenza





- BW 32 Ø 4 mm
- BW 34 150 mm
- BW 36 150 mm
- 1032 ○ 19+60 mm
- 1034 ○ 19+60 mm
- 1036 ● 19+60 mm
- 1038 ● 19+60 mm
- BW 1048 250 mm
- BW 1082BM ≡ 160 mm
- BW 1150BM ≡ 180 mm
- BW 1166BM ● 200 mm
- BW 1370 ≡ 500 g
- BW 1390 Ø 35 mm



- BW 42 ○ 6-7-8-9-10-11-12-13-14-15-16-17-18-19-20-21-22-23-24-27-30-32 mm
- BW 96BPC/SC9 ○ 1,5-2-2,5-3-4-5-6-8-10 mm

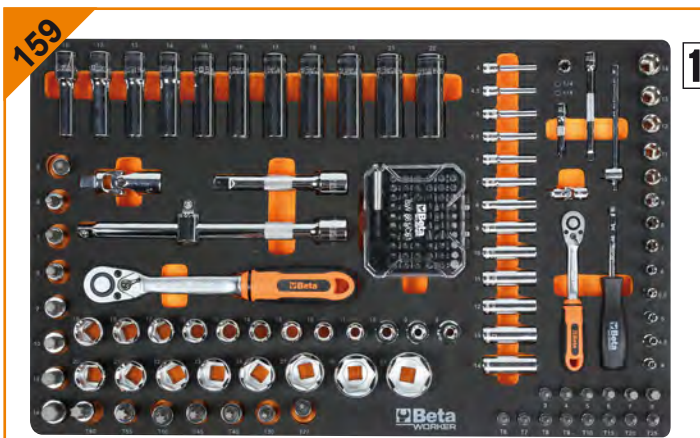

- 14** BW 900 ○ 4-4,5-5-5,5-6-7-8-9-10-11-12-13-14 mm
- BW 900L ○ 4-4,5-5-5,5-6-7-8-9-10-11-12-13-14 mm
- BW 900ME ○ 3-4-5-6-7-8 mm
- BW 900TX ○ T6-T7-T8-T9-T10-T15-T20-T25
- BW 895/1 ○ 1/4 - □ 1/4
- BW 900/20 50 mm
- BW 900/20L 100 mm
- BW 900/25 150 mm
- BW 900/30 115 mm
- BW 900/42 115 mm
- BW 900/55 ● 150 mm
- 12** BW 920A ○ 8-9-10-11-12-13-14-15-16-17-18-19-20-21-22-23-24-27-30-32 mm
- BW 920AL ○ 10-12-13-14-15-16-17-18-19-21-22 mm
- BW 920PE ○ 5-6-7-8-9-10-12-14 mm
- BW 920TX ○ T27-T30-T40-T45-T50-T55-T60
- BW 920/21 125 mm
- BW 920/22 250 mm
- BW 910/16F □ 3/8" - ■ 1/2"
- BW 920/25 ● 260 mm
- BW 920/55 ● 150 mm

BW 861/C61

| | | |
|---|----------|--|
| ● | BW 861LP | 0,5x3 (2)-0,5x4(2)-0,6x4,5(2)-0,8x5(2)-1,0x5,5(2)-1,0x6(2)-1,6x8(2) mm |
| + | BW 861PH | PH0(2)-PH1(7)-PH2(7)-PH3(2) |
| + | BW 861PZ | PZ0(2)-PZ1(3)-PZ2(3)-PZ3(2) |
| ○ | BW 861PE | 1,5-2-2,5-3-4-4,5-5-5,5-6-8 mm |
| ⊗ | BW 861TX | T9-T10-T15-T20-T25 T27-T30-T40 |
| □ | BW 882M1 | ○ 1/4 - ● 1/4 |



- 38** BW 55 ○ 6x7-8x9-10x11-12x13-14x15-16x17-18x19-20x22 mm
- BW 90 ○ 6x7-8x9-10x11-12x13-14x15-16x17-18x19-20x22 mm
- BW 910A ○ 6-7-8-9-10-11-12-13-14-15-16-17-18-19-20-21-22 mm
- BW 910AL ○ 8-10-11-12-13-14-17-19 mm
- BW 910PE ○ 4-5-6-7-8-9-10 mm
- BW 910TX ○ T15-T20-T25-T27-T30-T40-T45
- BW 910/20 75 mm
- BW 910/22 150 mm
- BW 910/25 ● 205 mm
- BW 910/55 □ 1/2" - ■ 3/8"
- BW 920/15F



- 1201E ● 2,5x50-3x75-4x100-5,5x125-6,5x150-8x200 mm
- 1202E + PH0x60-PH1x80-PH2x100-PH3x150 mm
- 1201EN ● 4x30 mm
- 1202EN + PH1x30 mm
- 1207E/TX ○ T6-T7-T8-T9-T10-T15-T20-T25-T27-T30-T40-T45
- BW 1256/C21-1**
 - BW 1256LP 1,5-2-2,5 mm
 - + BW 1256PH PH0-PH1
 - + BW 1256PZ PZ0-PZ1
 - BW 1256PE 0,7-0,9-1,3-1,5-2-2,5-3 mm
 - ⊗ BW 1256TX T4-T5-T6-T7
 - ⊗ BW 1256RTX T8-T10-T15
 - 4 mm



BW 2400S 8/E-L

Cassettiera mobile con otto cassetti e assortimento di 398 utensili

- 8 cassetti da 588x367 mm, montati su guide telescopiche a sfera:
 - 7 cassetti altezza 70 mm
 - 1 cassetto altezza 210 mm
- Piano dei cassetti protetto da tappetini di gomma espansa
- Quattro ruote Ø 125 mm:
 - 2 fisse e 2 girevoli (una con freno)
- Serratura di sicurezza centralizzata frontale
- Capacità di carico statico: 800 kg
- Piano di lavoro termoplastico
- Portaflaconi laterale integrato

800 kg



€ 1.699,00



024006241



024006242



024006243



| n° | h | max |
|----|--------|-------|
| 7 | 70 mm | 25 kg |
| 1 | 210 mm | 30 kg |

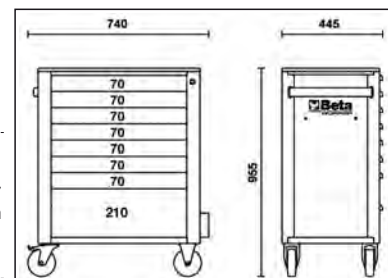
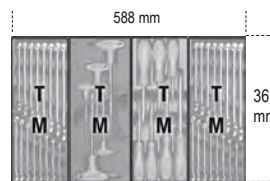
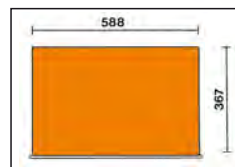

31

BW 42 6-7-8-9-10-11-12-13-14-15-16-17-18-19-20-21-22-23-24-27-30-32 mm
 BW 96BPC/SC9 1,5-2-2,5-3-4-5-6-8-10 mm



25

1201E 2,5x50-3x75-4x100-5,5x125-6,5x150-8x200 mm
 1201EN 4x30 mm
 1202E PH0x60-PH1x80-PH2x100-PH3x150 mm
 1202EN PH1x30 mm
 1207E/TX T6-T7-T8-T9-T10-T15-T20-T25-T27-T30-T40-T45
 BW 1253 0,5x100 mm

196



- 1/4"**
- BW 900 ○ 4-4,5-5-5,5-6-7-8-9-10-11-12-13-14 mm
 - BW 900L ○ 4,4-5-5,5-6-7-8-9-10-11-12-13-14 mm
 - BW 900FTX ○ E4-E5-E6-E7-E8-E10
 - BW 900ME ○ 3-4-5-6-7-8 mm
 - BW 900TX ○ T6-T7-T8-T9-T10-T15-T20-T25
 - BW 900LP ● 0,8x4-1x5,5-1,2x6,5-1,2x8 mm
 - BW 900PH ● PH0-PH1-PH2-PH3
 - BW 895/1 ○ 1/4" - □ 1/4"
 - BW 900/20 ○ 50 mm
 - BW 900/20L ○ 100 mm
 - BW 900/25 ○ 150 mm
 - BW 900/30 ○ 150 mm
 - BW 900/42 ○ 115 mm
 - BW 900/55 ● 150 mm

- 3/8"**
- BW 910A ○ 6-7-8-9-10-11-12-13-14-15-16-17-18-19-20-21-22-24 mm
 - BW 910AL ○ 8-10-11-12-13-14-17-19 mm
 - BW 910FTX ○ E6-E7-E8-E10-E11-E12-14
 - BW 910PE ○ 4-5-6-7-8-9-10 mm
 - BW 910TX ○ T15-T20-T25-T27-T30-40-T45
 - BW 910/21 ○ 125 mm
 - BW 910/22 ○ 150 mm
 - BW 910/25 ○ 150 mm
 - BW 910/55 ● 205 mm
 - BW 920/15F □ 1/2" - ■ 3/8"

BW 861/C61

| | | |
|---|----------|--|
| ⊖ | BW 861LP | 0,5x3 (2)-0,5x4(2)-0,6x4,5(2)-0,8x5(2)-1,0x5,5(2)-1,0x6(2)-1,6x8(2) mm |
| ⊕ | BW 861PH | PH0(2)-PH1(7)-PH2(7)-PH3(2) |
| ⊕ | BW 861PZ | PZ0(2)-PZ1(3)-PZ2(3)-PZ3(2) |
| ○ | BW 861PE | 1,5-2-2,5-3-4-4,5-5-5,5-6-8 mm |
| ⊕ | BW 861TX | T9-T10-T15-T20-T25 T27-T30-T40 |
| ○ | BW 882M1 | ○ 1/4 - ● 1/4 |

BW 1256/C21-1

| | | |
|------|------------|----------------------------|
| ⊖ | BW 1256LP | 1,5-2-2,5 mm |
| ⊕ | BW 1256PH | PH0-PH1 |
| ⊕ | BW 1256PZ | PZ0-PZ1 |
| ○ | BW 1256PE | 0,7-0,9-1,3-1,5-2-2,5-3 mm |
| ⊕ | BW 1256TX | T4-T5-T6-T7 |
| ⊕ | BW 1256RTX | T8-T10-T15 |
| 4 mm | | 99 mm |

78



- 12"**
- BW 920A ○ 8-9-10-11-12-13-14-15-16-17-18-19-20-21-22-23-24-27-30-32 mm
 - BW 920AL ○ 10-12-13-14-15-16-17-18-19-21-22-24-27-30-32 mm
 - BW 920FTX ○ E10-E12-E14-E16-E18-E20-E22-E24
 - BW 920PE ○ 5-6-7-8-9-10-12-14 mm
 - BW 920PE-L ○ 5-6-7-8-9-10-12-14 mm
 - BW 920TX ○ T27-T30-T40-T45-T50-T55-T60
 - BW 920TX-L ○ T30-T40-T45-T50-T55-T60-T70
 - BW 920/21 ○ 125 mm
 - BW 920/22 ○ 250 mm
 - BW 910/16F □ 3/8" - ■ 1/2"
 - BW 920/25 ○ 260 mm
 - BW 920/55 ● 260 mm

30



- BW 55 ○ 6x7-8x9-10x11-12x13-14x15-16x17-18x19-20x22-21x23-24x27-30x32 mm
- BW 90 ○ 6x7-8x9-10x11-12x13-14x15-16x17-18x19-20x22-21x23-24x27-30x32 mm
- BW 97TX/SC8 ○ T9-T10-T15-T20-T25-T27-T30-T40

13



- 1032 ○ 19+60 mm
- 1034 ○ 19+60 mm
- 1036 ● 19+60 mm
- 1038 ● 19+60 mm
- BW 1048 ○ 250 mm
- BW 1052 ○ 190 - 240 mm
- BW 1098 ○ 220 mm
- BW 1082BM ⊥ 160 mm
- BW 1150BM = 180 mm
- BW 1166BM ● 200 mm
- BW 1168BM ● 200 mm
- BW 1128BMX ○ 150 mm

25



- BW 30 Ø 2-3-4 mm
- BW 31 Ø 2-3-4-5-6-8 mm
- BW 32 Ø 4 mm
- BW 34 125-150-175 mm
- BW 36 150 mm
- BW 1370 500 g
- BW 1390 Ø 35 mm
- BW 1692/3 3 m
- BW 1712T 150+590 mm
- BW 1719BMA8/Q ■ 200 mm
- BW 1719BMA8/T ▲ 200 mm
- BW 1719BMA8/P I 200 mm
- BW 1719BMA8/M ● 200 mm
- BW 1719BMA8/R ● 200 mm
- BW 1737NX 270 mm
- 1771 18 mm

X
487

BW 2400S XL9/E-XL

Cassettiera mobile con nove cassetti, con sistema antiribaltamento, modello lungo, e assortimento di 487 utensili

- 9 cassetti da 882x367 mm, montati su guide telescopiche a sfera
- 8 cassetti altezza 70 mm
- 1 cassetto altezza 140 mm
- Piano di lavoro in ABS ad alta resistenza, con 6 vaschette portaminuteria
- Frontalino in nylon ad alta resistenza, con porta-etichette integrato
- Piano dei cassetti protetto da tappetini di gomma espansa
- Quattro ruote Ø 125 mm: 2 fisse e 2 girevoli (una con freno)
- Serratura di sicurezza centralizzata frontale
- Capacità di carico statico: 1.000 kg
- Portaflaconi laterale integrato

1000 kg



€ 2.499,00



024006251



024006252



024006253



| n° | h | max |
|----|--------|-------|
| 8 | 70 mm | 30 kg |
| 1 | 140 mm | 35 kg |

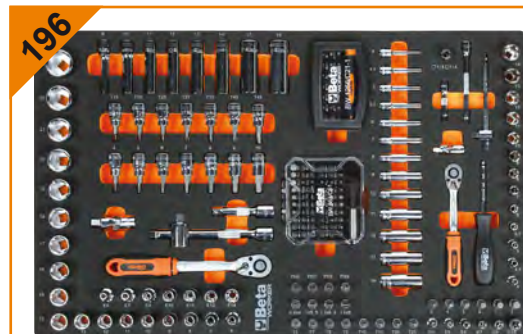
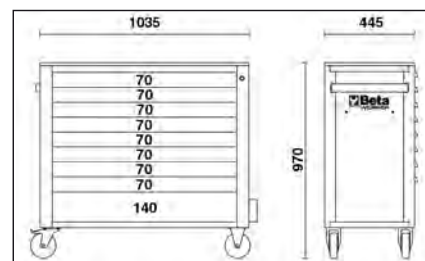
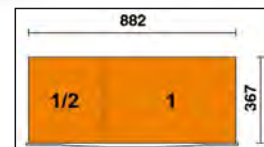

196

| 1/4" | BW 900 | ○ 4-4,5-5-5,5-6-7-8-9-10-11-12-13-14 mm |
|------|------------|---|
| | BW 900L | ○ 4,4,5-5,5-6-7-8-9-10-11-12-13-14 mm |
| | BW 900FTX | ⊗ E4-E5-E6-E7-E8-E10 |
| | BW 900ME | ○ 3-4-5-6-7-8 mm |
| | BW 900TX | ⊗ T6-T7-T8-T9-T10-T15-T20-T25 |
| | BW 900LP | ● 0,8x4-1x5,5-1,2x6,5-1,2x8 mm |
| | BW 900PH | ⊕ PH0-PH1-PH2-PH3 |
| | BW 895/1 | ○ 1/4" - □ 1/4" |
| | BW 900/20 | 50 mm |
| | BW 900/20L | 100 mm |
| | BW 900/25 | 150 mm |
| | BW 900/30 | 115 mm |
| | BW 900/42 | 115 mm |
| | BW 900/55 | ⊗ 150 mm |

| 3/8" | BW 910A | ○ 6-7-8-9-10-11-12-13-14-15-16-17-18-19-20-21-22-24 mm |
|------|------------|--|
| | BW 910AL | ○ 8-10-11-12-13-14-17-19 mm |
| | BW 910FTX | ⊗ E6-E7-E8-E10-E11-E12-14 |
| | BW 910PE | ○ 4-5-6-7-8-9-10 mm |
| | BW 910TX | ⊗ T15-T20-T25-T27-T30-40-T45 |
| | BW 910/20 | 75 mm |
| | BW 910/22 | 150 mm |
| | BW 910/25 | |
| | BW 910/55 | ⊗ 205 mm |
| | BW 920/15F | □ 1/2" - ■ 3/8" |

BW 861/C61

| | | |
|---|----------|--|
| ⊕ | BW 861LP | 0,5x3 (2)-0,5x4(2)-0,6x4,5(2)-0,8x5(2)-1,0x5,5(2)-1,0x6(2)-1,6x8(2) mm |
| ⊕ | BW 861PH | PH0(2)-PH1(7)-PH2(7)-PH3(2) |
| ⊕ | BW 861PZ | PZ0(2)-PZ1(3)-PZ2(3)-PZ3(2) |
| ⊕ | BW 861PE | 1,5-2-2,5-3-4-4,5-5-5,5-6-8 mm |
| ⊕ | BW 861TX | T9-T10-T15-T20-T25 T27-T30-T40 |
| | BW 882M1 | ○ 1/4 - ● 1/4 |

BW 1256/C21-1

| | | |
|---|------------|----------------------------|
| ⊕ | BW 1256LP | 1,5-2-2,5 mm |
| ⊕ | BW 1256PH | PH0-PH1 |
| ⊕ | BW 1256PZ | PZ0-PZ1 |
| ⊕ | BW 1256PE | 0,7-0,9-1,3-1,5-2-2,5-3 mm |
| ⊕ | BW 1256TX | T4-T5-T6-T7 |
| ⊕ | BW 1256RTX | T8-T10-T15 |
| | 4 mm | 99 mm |



BW 42 6-7-8-9-10-11-12-13-14-15-16-17-18-19-20-21-22-23-24-27-30-32 mm
BW 96BPC/SC9 1,5-2-2,5-3-4-5-6-8-10 mm



BW 55 6x7-8x9-10x11-12x13-14x15-16x17-18x19-20x22-21x23-24x27-30x32 mm
BW 90 6x7-8x9-10x11-12x13-14x15-16x17-18x19-20x22-21x23-24x27-30x32 mm
BW 97TX/SC8 T9-T10-T15-T20-T25-T27-T30-T40



1032 19÷60 mm
1034 19÷60 mm
1036 19÷60 mm
1038 19÷60 mm
BW 1048 250 mm
BW 1052 190 - 240 mm
BW 1098 220 mm
BW 1082BM 160 mm
BW 1150BM 180 mm
BW 1166BM 200 mm
BW 1168BM 200 mm
BW 1128BMX 150 mm



BW 920A 8-9-10-11-12-13-14-15-16-17-18-19-20-21-22-23-24-27-30-32 mm
BW 920AL 10-12-13-14-15-16-17-18-19-21-22-24-27-30-32 mm
BW 920FTX E10-E12-E14-E16-E18-E20-E22-E24
BW 920PE 5-6-7-8-9-10-12-14 mm
BW 920PE-L 5-6-7-8-9-10-12-14 mm
BW 920TX T27-T30-T40-T45-T50-T55-T60
BW 920TX-L T30-T40-T45-T50-T55-T60-T70
BW 920/21 125 mm
BW 920/22 250 mm
BW 910/16F 3/8" - 1/2"
BW 920/25 3/8" - 1/2"
BW 920/55 260 mm

12"



BW 720 10-12-13-15-17-19-21-24 mm
BW 720L 17-19-21-22 mm
BW 720/21 125 mm
BW 900/16 1/4" - 3/8"
BW 910/15 3/8" - 1/4"
BW 910/16F 3/8" - 1/2"
BW 920/15F 1/2" - 3/8"
BW 920/16 1/2" - 3/4"
BW 943FL 6-7-8 mm
BW 1687D 153 mm
BW 1687U 153 mm
BW 1687A 153 mm
BW 1687AC 153 mm



BW 1370 500 g
BW 1380 1000 g
BW 1390 35 mm
BW 1737NX

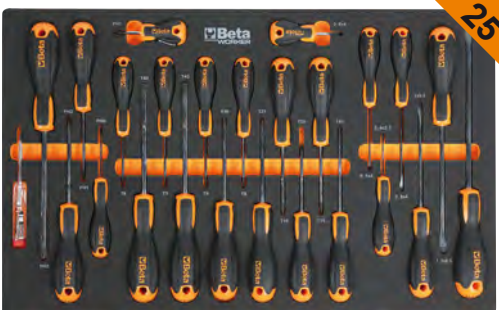

1201E 2,5x50-3x75-4x100-5,5x125-6,5x150-8x200 mm
1201EN 4x30 mm
1202E PH0x60-PH1x80-PH2x100-PH3x150 mm
1202EN PH1x30 mm
1207E/TX T6-T7-T8-T9-T10-T15-T20-T25-T27-T30-T40-T45
BW 1253 0,5x100 mm



BW 141 8-9-10-11-12-13-14-15-17-19 mm
BW 410/SP19 1+10 mm x 0.5 mm
BW 1725CR 260 mm

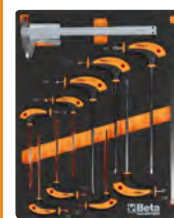

BW 977TX T8-T9-T10-T15-T20-T25-T27-T30-T40
BW 1682 300 mm
BW 1650 150 mm



BW 30 2-3-4 mm
BW 31 2-3-4-5-6-8 mm
BW 32 4 mm
BW 34 125-150-175 mm
BW 1692/3 3 m
BW 1712T 150+590 mm
BW 1725 420 mm
BW 1719BMA8/T 200 mm
BW 1719BMA8/P 200 mm
BW 1719BMA8/M 200 mm
BW 1719BMA8/R 200 mm
BW 1719BMA8/Q 200 mm
1771 18 mm
BW 1833S 200 lumen



BW 1149F 175 mm
BW 1602 0,75+6 mm²
BW 1603 1,25+5,5 mm²
BW 1606T 0,1+10 mm²
BW 1608 0,5+6 mm²



943E 6-7-8-9-10-11-12-13 mm

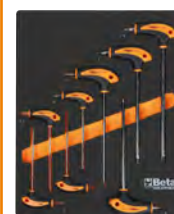

BW 96T 2-2,5-3-4-5-6-7-8 mm

LA TUA OFFICINA SU RUOTE!

**X
716**

BW 2400S XL9/E-XXL

Cassettiera mobile con nove cassetti, con sistema antiribaltamento, modello lungo, e assortimento di 716 utensili - unico in Italia!

- 9 cassetti da 882x367 mm, montati su guide telescopiche a sfera:
 - 8 cassetti altezza 70 mm
 - 1 cassetto altezza 140 mm
- Piano di lavoro in ABS ad alta resistenza, con 6 vaschette portaminuteria
- Frontalino in nylon ad alta resistenza, con porta-etichette integrato
- Piano dei cassetti protetto da tappetini di gomma espansa
- Quattro ruote Ø 125 mm:
 - 2 fisse e 2 girevoli (una con freno)
- Serratura di sicurezza centralizzata frontale
- Capacità di carico statico: 1.000 kg
- Portaflaconi laterale integrato

1000 kg



€ 2.899,00



024006254



024006255



024006256



| n° | h | max |
|----|--------|-------|
| 8 | 70 mm | 30 kg |
| 1 | 140 mm | 35 kg |

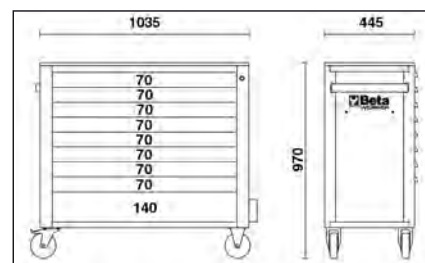
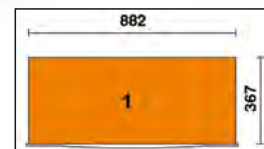

BW 97TX/SC8 ○ T9-T10-T15-T20-T25-T27-T30-T40
 BW 97TTX ○ T8-T9-T10-T15-T20-T25-T27-T30-T40

3/8" BW 910A ○ 6-7-8-9-10-11-12-13-14-15-16-17-18-19-20-21-22-24 mm
 BW 910AL ○ 8-10-11-12-13-14-17-19 mm
 BW 910FTX ⊗ E6-E7-E8-E10-E11-E12-E14
 BW 910PE ○ 4-5-6-7-8-9-10 mm
 BW 910TX ○ T15-T20-T25-T27-T30-T40-T45

BW 910/20 75 mm
 BW 910/22 150 mm
 BW 910/25
 BW 910/55 ⊗ 200 mm
 BW 920/15F □ 1/2" - ■ 3/8"

1/4" BW 900 ○ 4-4,5-5-5,5-6-7-8-9-10-11-12-13-14 mm
 BW 900L ○ 4-4,5-5-5,5-6-7-8-9-10-11-12-13-14 mm
 BW 900FTX ⊗ E4-E5-E6-E7-E8-E10
 BW 900ME ○ 3-4-5-6-7-8-10 mm
 BW 900TX ○ T6-T7-T8-T9-T10-T15-T20-T25
 BW 900LP ● 0,8x4-1,0x5,5-1,2x6,5-1,2x8 mm

BW 900PH ⊕ PH0-PH1-PH2-PH3
 BW 895/1 ⊗ 16
 BW 900/20 50 mm
 BW 900/20L 100 mm
 BW 900/25
 BW 900/30 150 mm
 BW 900/42 115 mm
 BW 900/55 ⊗ 150 mm

BW 861/C61

| | | | |
|---|---|----------|--|
| ● | ○ | BW 861LP | 0,5x3 (2)-0,5x4(2)-0,6x4,5(2)-0,8x5(2)-1,0x5,5(2)-1,0x6(2)-1,6x8(2) mm |
| ⊕ | ○ | BW 861PH | PH0(2)-PH1(7)-PH2(7)-PH3(2) |
| ⊕ | ○ | BW 861PZ | PZ0(2)-PZ1(3)-PZ2(3)-PZ3(2) |
| ○ | ○ | BW 861PE | 1,5-2-2,5-3-4-4,5-5-5,5-6-8 mm |
| ⊗ | ○ | BW 861TX | T9-T10-T15-T20-T25 T27-T30-T40 |
| ○ | ○ | BW 882M1 | ○ 1/4 - ● 1/4 |

BW 1256/C21-1

| | | | |
|------|---|------------|----------------------------|
| ● | ○ | BW 1256LP | 1,5-2-2,5 mm |
| ⊕ | ○ | BW 1256PH | PH0-PH1 |
| ⊕ | ○ | BW 1256PZ | PZ0-PZ1 |
| ○ | ○ | BW 1256PE | 0,7-0,9-1,3-1,5-2-2,5-3 mm |
| ⊗ | ○ | BW 1256TX | T4-T5-T6-T7 |
| ⊗ | ○ | BW 1256RTX | T8-T10-T15 |
| 4 mm | ○ | | 99 mm |



97

- 12"** BW 720L ○ 10-12-13-15-17-19-21-24-27-30 mm
 BW 720/21 125 mm
 BW 720/25 64 mm
 BW 910/16F □ 3/8" - ■ 1/2"
 BW 920/16 □ 1/2" - ■ 3/4"
 BW 920A ○ 8-9-10-11-12-13-14-15-16-17-18-19-20-21-22-23-24-27-30-32 mm
 BW 920AL ○ 10-12-13-14-15-16-17-18-19-21-22-24-27-30-32 mm
 BW 920FTX ○ E10-E12-E14-E16-E18-E20-E22-E24
 BW 920PE ○ 5-6-7-8-9-10-12-14 mm
 BW 920PE-L ○ 5-6-7-8-9-10-12-14 mm
 BW 920PE-XL ○ 10-12-14 mm
 BW 920TX ⊕ T27-T30-T40-T45-T50-T55-T60
 BW 920TX-L ⊕ T30-T40-T45-T50-T55-T60-T70
 BW 920TX-XL ⊕ T45-T50-T55
 BW 920/21 125 mm
 BW 920/22 250 mm
 BW 920/25 250 mm
 BW 920/55 ⊕ 260 mm



35

- 943E ○ 5-5,5-6-7-8-9-10-11-12-13-14 mm
 1201E ⊕ 2,5x50-3x75-4x100-5,5x125-6,5x150-8x200 mm
 1202E ⊕ PH0x60-PH1x80-PH2x100-PH3x150 mm
 1201EN ⊕ 4x30 mm
 1202EN ⊕ PH1x30 mm
 1207E/TX ○ T6-T7-T8-T9-T10-T15-T20-T25-T27-T30-T40-T45



235

- BW 96BPC/SC9 ○ 1,5-2-2,5-3-4-5-6-8-10 mm
 BW 410/SP19 1+10 mm x 0,5 mm
 BW 666N/20 40+20 Nm
 BW 720 ○ 10-12-13-15-17-19-21-24-27-30 mm
 BW 867PE ○ 4-5-6-7-8-10-12 mm
 BW 867PE/L ○ 4-5-6-7-8-10-12 mm
 BW 867XZN ○ 4-5-6-7-8-10-12 mm
 BW 867XZN/L ○ 5-6-8-10-12 mm
 BW 867TX ⊕ T20-T25-T30-T40-T45-T50-T55
 BW 867TX/L ⊕ T20-T25-T30-T40-T45-T50-T55
 BW 867RTX ⊕ T20-T25-T30-T40-T45-T50-T55
 BW 867RTX/L ⊕ T20-T25-T30-T40-T45-T50-T55
 BW 867RIB/L ⊕ T20-T25-T30-T40-T45-T50-T55
 BW 867/1 ○ 10 mm - □ 3/8"
 BW 867/2 ○ 10 mm - □ 1/2"
 BW 867RIBE ⊕ 5-6-7-8-9-10-11-12-13 mm
 BW 867RIBE/L ⊕ 5-6-7-8-9-10-11-12-13 mm
 BW 1253 ⊕ 0,5x100 mm
 BW 1257LP ⊕ 2,0-2,5-3,0 mm
 BW 1257PH ⊕ PH00-PH0-PH1
 BW 1257TX ⊕ T5-T6-T7-T8-T9-T10
 BW 1728BM
 BW 1728LA

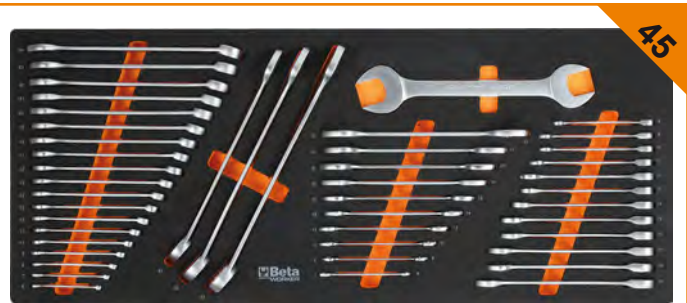

45

- BW 42 ⊕ 6-7-8-9-10-11-12-13-14-15-16-17-18-19-20-21-22-23-24-27-30-32 mm
 BW 55 ⊕ 6x7-8x9-10x11-12x13-14x15-16x17-18x19-20x22-21x23-24x27-30x32 mm
 BW 141 ⊕ 8-9-10-11-12-13-14-15-16-17-18-19 mm

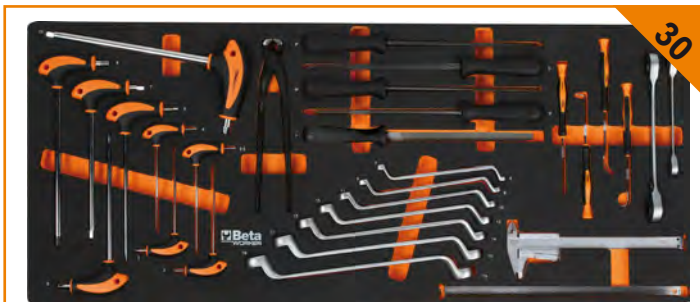

30

- BW 90 ⊕ 6x7-8x9-10x11-12x13-14x15-16x17-18x19 mm
 BW 96T ○ 2,2-2,5-3-4-5-6-7-8-10 mm
 BW 1098 220 mm
 BW 1650 150 mm
 BW 1682 300 mm
 BW 1687/S4
 BW 192 8x10/12x13 mm
 BW 192 16x17/18x19 mm
 BW 1719BMA8/Q ■ 200 mm
 BW 1719BMA8/T ▲ 200 mm
 BW 1719BMA8/P ▮ 200 mm
 BW 1719BMA8/M ▽ 200 mm
 BW 1719BMA8/R ● 200 mm



33

- BW 943FL ○ 6-7-8 mm
 BW 1692/5 5 m
 BW 1712T 148+665 mm
 BW 1606T 0,08+6 ⇨ mm²
 BW 1608 0,5+6 ⇨ mm²
 BW 1725 420 mm
 BW 1725CR 250 mm
 BW 1737NX 270 mm
 1771 18 mm
 BW 1771RL 18 mm
 BW 1833S 200 lumen
 BW 1715
 BW 1720/B6
 BW 1128BMX 150 mm
 BW 1149F 0,2+6 ⇨ mm²
 BW 1602 0,75+6 ⇨ mm²
 BW 1603 1,25+5,5 ⇨ mm²

059456301

BW 5945/2023

Assortimento di 268 utensili per utilizzo universale, in vassoio morbido in EVA

€ 890,00

X
268

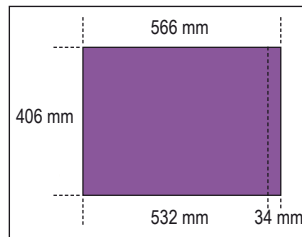

per **C45PRO 2.0**



17

- BW 96T ○ 2-2,5-3-4-5-6-7-8 mm
- BW 34 150-175 mm
- BW 1370 300 g
- BW 1390 Ø 35 mm
- BW 1719BMA8/Q ■ 200 mm
- BW 1719BMA8/T ▲ 200 mm
- BW 1719BMA8/P ▽ 200 mm
- BW 1719BMA8/M ▽ 200 mm
- BW 1719BMA8/R ● 200 mm



36

- BW 97TTX ○ T10-T15-T20-T25-T30
- 1038 ● 19+60 mm
- 1036 ● 19+60 mm
- 1034 ○ 19+60 mm
- 1032 ○ 19+60 mm
- BW 1166BM ● 160 mm
- BW 1150BM = 180 mm
- BW 1082BM ≡ 160 mm
- BW 1052 240 mm
- BW 1048 250 mm

BW 1256/C21-1

| | | |
|------|------------|----------------------------|
| ● | BW 1256LP | 1,5-2-2,5 mm |
| + | BW 1256PH | PH0-PH1 |
| + | BW 1256PZ | PZ0-PZ1 |
| ○ | BW 1256PE | 0,7-0,9-1,3-1,5-2-2,5-3 mm |
| ○ | BW 1256TX | T4-T5-T6-T7 |
| ○ | BW 1256RTX | T8-T10-T15 |
| 4 mm | | 99 mm |



30

- BW 96BPC/S C9 ○ 1,5-2-2,5-3-4-5-6-8-10 mm
- BW 42 ○ 6-7-8-9-10-11-12-13-14-15-16-17-18-19-20-21-22-24-27-30-32 mm



25

- 1202E ● PH0x60-PH1x80-PH2x100-PH3x150 mm
- 1202EN ● PH1X30 mm
- 1207E/TX ○ T6-T7-T8-T9-T10-T15-T20-T25-T27-T30-T40-T45
- 1201EN ● 4x30 mm
- 1201E ● 2,5x50-3x75-4x100-5,5x125-6,5x150-8x200 mm
- BW 1253 ● 3x100 mm



160

- 14" BW 900 ○ 4-4,5-5-5,5-6-7-8-9-10-11-12-13-14 mm
- BW 900L ○ 5-6-7-8-9-10-11-12-13 mm
- BW 900LP ● 0,8x4-1,0x5,5-1,2x6,5-1,2x8,0 mm
- BW 900PH ● PH1-PH2-PH3
- BW 900ME ○ 3-4-5-6-7 mm
- BW 900TX ○ T10-T15-T20-T25-T27-T30
- BW 900/20 50 mm
- BW 900/20L 100 mm
- BW 900/25 150 mm
- BW 900/30 150 mm
- BW 895/1 ○ 1/4" - □ 1/4"
- BW 900/42 115 mm
- BW 900/55 ● 150 mm
- BW 900/42 115 mm
- BW 900/55 ● 150 mm

- 12" BW 895/6 ○ 5/16" - □ 1/2"
- BW 956C ○ 16 mm - 20,8 mm
- BW 920/15F □ 1/2" - ■ 3/8"
- BW 910/22 150 mm
- BW 910/55 ● 205 mm
- BW 920/55 ● 260 mm
- BW 920A ○ 8-10-11-12-13-14-15-16-17-18-19-20-21-22-23-24-26-27-28-30-32 mm
- BW 920/25 125 mm
- BW 920/21 125 mm
- BW 920/22 255 mm

BW 861/C61

| | | |
|---|----------|--|
| ● | BW 861LP | 0,5x3 (2)-0,5x4(2)-0,6x4,5(2)-0,8x5(2)-1,0x5,5(2)-1,0x6(2)-1,6x8(2) mm |
| + | BW 861PH | PH0(2)-PH1(7)-PH2(7)-PH3(2) |
| + | BW 861PZ | PZ0(2)-PZ1(3)-PZ2(3)-PZ3(2) |
| ○ | BW 861PE | 1,5-2-2,5-3-4-4,5-5-5,5-6-8 mm |
| ○ | BW 861TX | T9-T10-T15-T20-T25 T27-T30-T40 |
| ○ | BW 882M1 | ○ 1/4 - ● 1/4 |

- 38" BW 910A ○ 6-7-8-9-10-11-12-13-14-15-16-17-18-19-20-21-22 mm
- BW 910/20 75 mm
- BW 910/22 150 mm
- BW 910/25 150 mm
- BW 910/16F □ 3/8" - ■ 1/2"
- BW 895/3 ○ 1/4" - □ 3/8"
- BW 910/55 ● 205 mm

012566122



BW 1256/C21-1

Microgiravite con 21 inserti intercambiabili da 4 mm e impugnatura

€ 16,50

X
22



| | | | |
|------|--|------------|----------------------------|
| ● | | BW 1256LP | 1,5-2-2,5 mm |
| + | | BW 1256PH | PH0-PH1 |
| + | | BW 1256PZ | PZ0-PZ1 |
| ○ | | BW 1256PE | 0,7-0,9-1,3-1,5-2-2,5-3 mm |
| ⊗ | | BW 1256TX | T4-T5-T6-T7 |
| ⊕ | | BW 1256RTX | T8-T10-T15 |
| 4 mm | | | 99 mm |

008606992



BW 860EA/31

Serie di 30 inserti con portainseri, in astuccio tascabile

€ 19,50

X
31



| | | | |
|---|--|----------|--|
| ● | | BW 861LP | 0,5x3-0,6x4,5-0,8x5,5-1,0x5,5-1,2x6,5-1,6x8 mm |
| + | | BW 861PH | 1-2-3 |
| + | | BW 861PZ | 1-2-3 |
| ○ | | BW 861PE | 2-3-4-5-6-8 mm |
| ⊗ | | BW 861TX | T8-T9-T10-T15-T20-T25-T27-T30-T40 |
| ○ | | BW 861PQ | 1-2-3 mm |
| | | BW 882M1 | ○ 1/4 - ● 1/4 |

008616961



BW 861/C61

Serie di 60 inserti con portainseri magnetico, in astuccio tascabile

€ 29,50

X
61



| | | | |
|---|--|----------|--|
| ● | | BW 861LP | 0,5x3 (2)-0,5x4(2)-0,6x4,5(2)-0,8x5(2)-1,0x5,5(2)-1,0x6(2)-1,6x8(2) mm |
| + | | BW 861PH | PH0(2)-PH1(7)-PH2(7)-PH3(2) |
| + | | BW 861PZ | PZ0(2)-PZ1(3)-PZ2(3)-PZ3(2) |
| ○ | | BW 861PE | 1,5-2-2,5-3-4-4,5-5-5,5-6-8 mm |
| ⊗ | | BW 861TX | T9-T10-T15-T20-T25 T27-T30-T40 |
| | | BW 882M1 | ○ 1/4 - ● 1/4 |

Cricchetto reversibile con attacco quadro maschio, cromato

- Ingombro minimo della testa
- Inversione con una sola mano



| | L mm | Ø mm | A mm | ■ | Denti | | € |
|------------|------|------|------|------|-------|-----------|---------|
| BW 900E/55 | 127 | 26 | 25 | 1/4" | | 009006880 | € 27,00 |
| BW 910E/55 | 200 | 31 | 33 | 3/8" | | 009106880 | € 29,00 |
| BW 920E/55 | 264 | 40 | 43 | 1/2" | | 009206880 | € 35,00 |

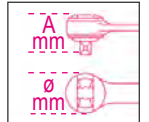

Cricchetto reversibile con attacco quadro maschio, cromato

- Ingombro minimo della testa
- Inversione con una sola mano
- Pulsante di rilascio della bussola



| | L mm | Ø mm | A mm | ■ | Denti | | € |
|-----------|------|------|------|------|-------|-----------|---------|
| BW 900/55 | 150 | 23 | 37 | 1/4" | | 009006870 | € 27,00 |
| BW 910/55 | 200 | 30 | 38 | 3/8" | | 009106872 | € 29,00 |
| BW 920/55 | 250 | 37 | 42 | 1/2" | | 009206872 | € 35,00 |

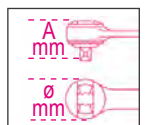

Cricchetto reversibile con attacco quadro maschio 3/4" cromato

- Meccanismo a 24 denti
- Angolo di ripresa di 15°



| | L mm | Ø mm | A mm | ■ | Denti | | € |
|-----------|------|------|------|------|-------|-----------|---------|
| BW 928/55 | 505 | 59 | 60 | 3/4" | | 009286862 | € 93,00 |

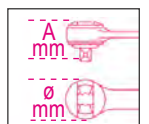

Beta WORKER



Le immagini sono indicative, Beta Utensili si riserva il diritto di apportare aggiornamenti e migliorie alla propria gamma produttiva senza alcun preavviso.



Beta
WORKER

Beta Utensili S.p.A.
via Volta, 18 - 20845 Sovico (MB)
tel +39 039 20771
www.beta-tools.com

