







**TABELLA TECNICA  
TENDIFILI AGRICOLTURA ART. 8515V-Z**

Indicazioni di smaltimento imballaggi		
Simbolo		Indicazioni raccolta
		
		Raccolta plastica: buste di plastica, bottiglie di plastica, flaconi ecc...
		Raccolta carta: cartone ondulato (scatole imballaggio)
Verifica le disposizioni del tuo comune		

- 1) Acciaio impiegato: S235JR UNI EN 10025-2
- 2) Trattamento Superficiale: Art. 8515V: verniciatura PVC verde (RAL 6005)  
Art. 8515Z: zincatura (A2E UNI EN ISO 4042)
- 3) Il collaudo viene eseguito in base a specifiche e regole interne in riferimento alla norma UNI EN ISO 9001.

## 4) Istruzioni Operative:

- L'articolo non deve essere utilizzato nel caso di usura o presenza di eventuali cricche.
- I dati indicati si riferiscono all'utilizzo del prodotto a temperatura ambiente
- Ispezionare sempre il prodotto prima dell'utilizzo.

- 5) Marcatura: Diametro della fune da utilizzare.

**ATTENZIONE**

Questo documento è valido fino a che permangono inalterate le nostre condizioni tecniche di fornitura. Eventuali modifiche, lavorazioni, trattamenti successivi, ci esonerano da qualsiasi responsabilità.

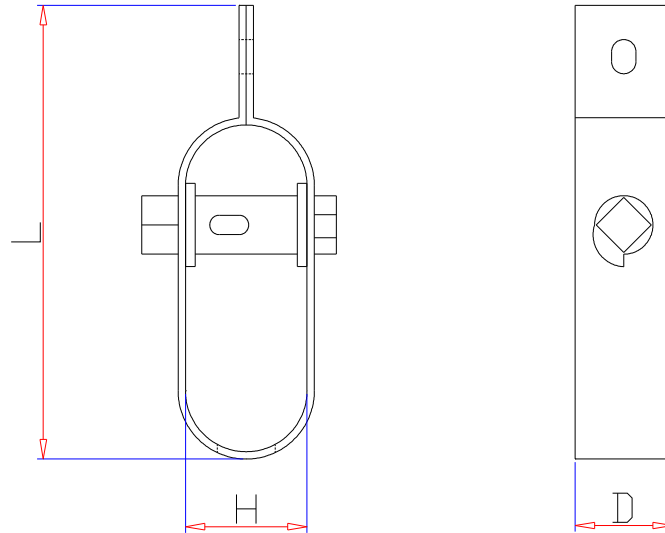





**TABELLA TECNICA  
TENDIFILI AGRICOLTURA ART. 8515V-Z**

Le quote indicate sono espresse in mm.

MISURA	D	H	L	g	CODICE	
					ZINCATO	VERNICIATO
2	20	25	90	80	085150002	085150102
3	25	30	100	110	085150003	085150103

SERVIZIO QUALITA'

**TECHNICAL TABLE  
WIRE TENDER ITEM 8515V-Z**

Disposal packaging instruction		
Simbology		Collection indication
		
	 LDPE	Plastic collection: plastic bags, plastic bottle, vials etc..
	 20 PAP	Paper collection: corrugated cardboard (packaging boxes)
Check the provisions of your country.		

- 1) Steel type used: S235JR UNI EN 10025-2
- 2) Surface treatment: Art. 8515V: painted PVC green (RAL 6005)  
Art. 8515Z: galvanized (A2E UNI EN ISO 4042)
- 3) The inspection is performed in accordance with specifications and in-house regulations referring to the UNI EN ISO 9001 standard.
- 4) Operating instructions:
  - This item should not be used if it is worn or cracked.
  - The indicated data are referred to products used at environmental temperature.
  - Before using the product always check it
- 5) Marking: Diameter of rope to use.

**WARNING!**

This document shall be valid until our technical terms and conditions are changed.

We shall not be liable for any subsequent modifications, working techniques and treatments.

For any controversy refer to technical table written in Italian.

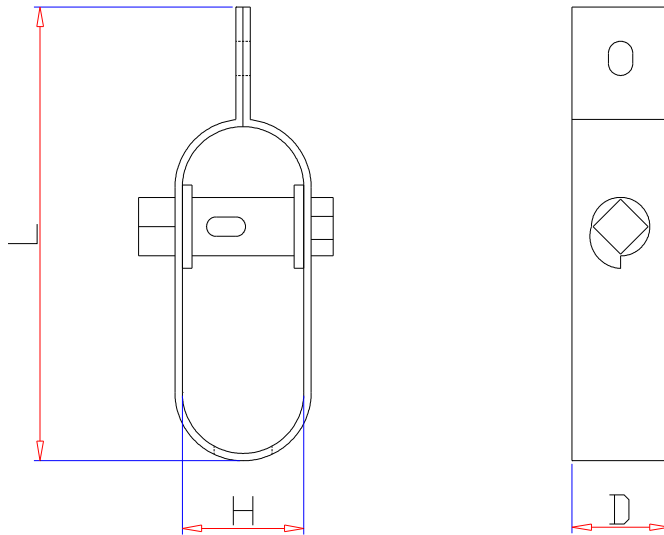
**TECHNICAL TABLE  
WIRE TENDER ITEM 8515V-Z**

**The dimensions are expressed in mm.**

SIZE	D	H	L	 g	CODE	
					GALVANIZED	PAINTED
2	20	25	90	80	085150002	085150102
3	25	30	100	110	085150003	085150103

QUALITY SERVICE